

# VISUELS MOBILES / FREE STANDING BRANDING

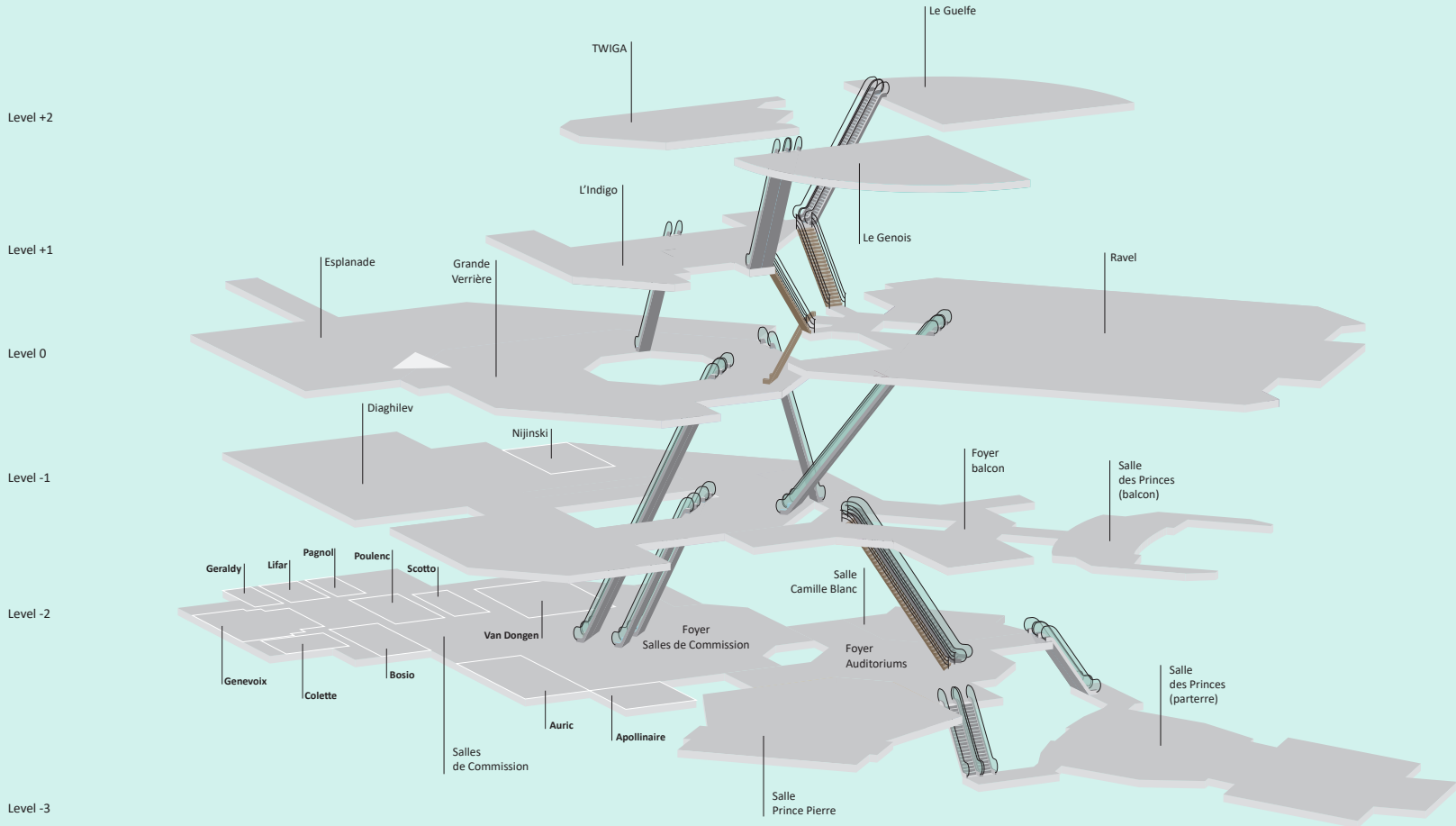

200a

## TOTEM MOBILE / TOTEM

Format A3 :  
142 cm x H29,7 cm (WxH)



## CARACTÉRISTIQUES / CHARACTERISTICS

1 à 3 visuels format A3 paysage.  
1 to 3 visuals A3 landscape.

201

**VISUEL MOBILE STRUCTURE X'PO /  
VISUAL X'PO STRUCTURE**



**CARACTÉRISTIQUES / CHARACTERISTICS**

Impression numérique sur bâche  
Digital print on fabric.

**DIMENSIONS VISIBLES/ VISIBLE SIZE**

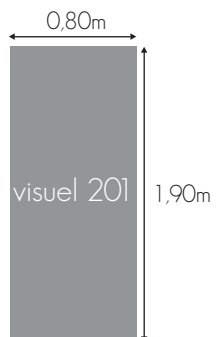

## VISUEL MOBILE TYPE CIGOGNE / VISUAL « TYPE CIGOGNE »

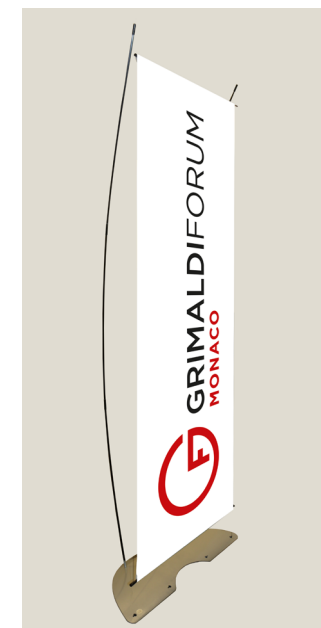
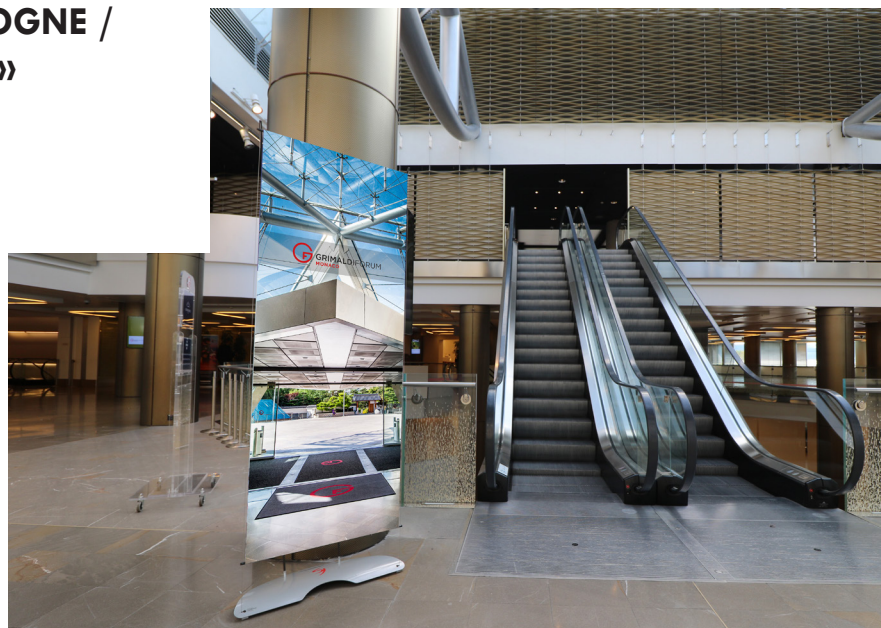

### CARACTÉRISTIQUES / CHARACTERISTICS

Impression numérique sur bâche avec fourreaux.  
Digital print on fabric banner with sleeves.



### DIMENSIONS VISIBLES/ VISIBLE SIZE

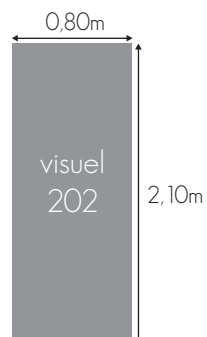

203

**VISUEL MOBILE 2 FACES TYPE  
SODEM /  
VISUAL 2 SIDES « TYPE SODEM »**



**CARACTÉRISTIQUES / CHARACTERISTICS**

Impression numérique sur forex.  
Digital print on foamex.

**DIMENSIONS VISIBLES/ VISIBLE SIZE**

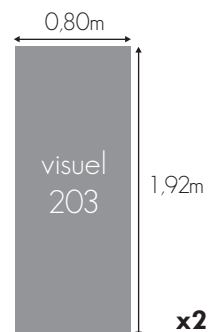

204a

**CUBE MOBILE /  
CUBE**

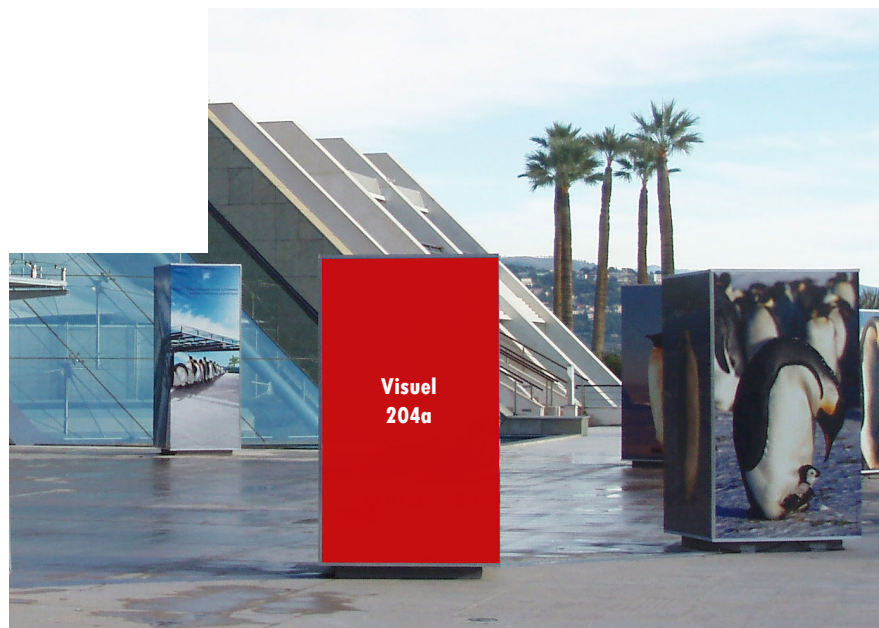

**CARACTÉRISTIQUES / CHARACTERISTICS**

Impression numérique sur forex 5mm.  
Digital print on foamex 5mm.



**Les 4 faces sont individuelles  
The 4 sides are individual**

**DIMENSIONS VISIBLES/ VISIBLE SIZE**

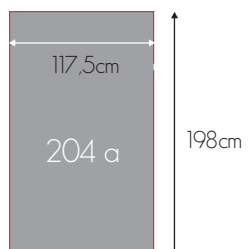

## PANNEAU POSTER / POSTER BOARD



**Visuel 206**  
1,20 x 1,50 m



### CARACTÉRISTIQUES / CHARACTERISTICS

Forex imprimé et fixé sur le panneau poster.  
Foamex print on poster board.

### DIMENSIONS VISIBLES/ VISIBLE SIZE

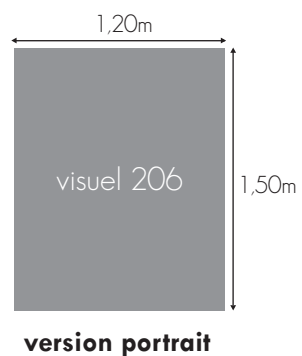
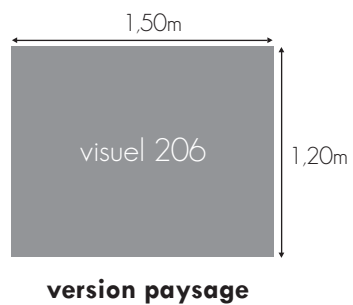

## 207a, 207b

### CLAUSTRA / CLAUSTRA



### CARACTÉRISTIQUES / CHARACTERISTICS

Forex imprimé et fixé sur claustra.  
Foamex fixed on screen wall.

### DIMENSIONS VISIBLES/ VISIBLE SIZE

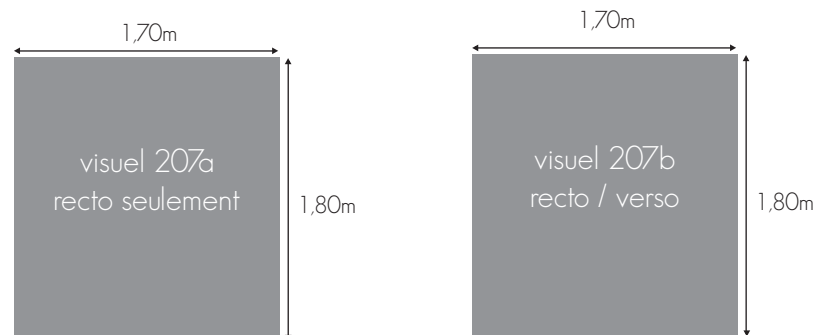

208

**VISUEL SUR PUPITRE /  
VISUAL ON LECTURN**



**CARACTÉRISTIQUES / CHARACTERISTICS**

Forex imprimé et fixé sur le pupitre.  
Foamex print on desk.

**DIMENSIONS VISIBLES/ VISIBLE SIZE**

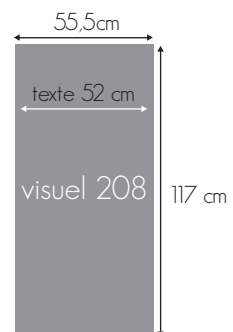

209

## VISUEL SUR TABLE DE CONFÉRENCE / VISUAL ON CONFERENCE TABLE



### CARACTÉRISTIQUES / CHARACTERISTICS

Forex imprimé et fixé sur la table de conférence.  
Foamex print on conference table.

### DIMENSIONS VISIBLES/ VISIBLE SIZE

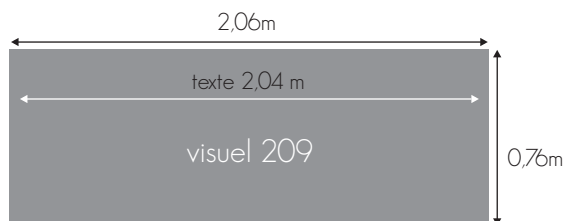

## 210a, 210b, 210c, 210d

### VISUEL MOBILE / FREE STANDING VISUAL



**Visuel 210a**  
0,80 x 1,80 m



**Visuel 210c**  
1,20 x 1,80 m



### CARACTÉRISTIQUES / CHARACTERISTICS

Forex imprimé et fixé sur socle.  
Foamex free standing.

### DIMENSIONS VISIBLES/ VISIBLE SIZE

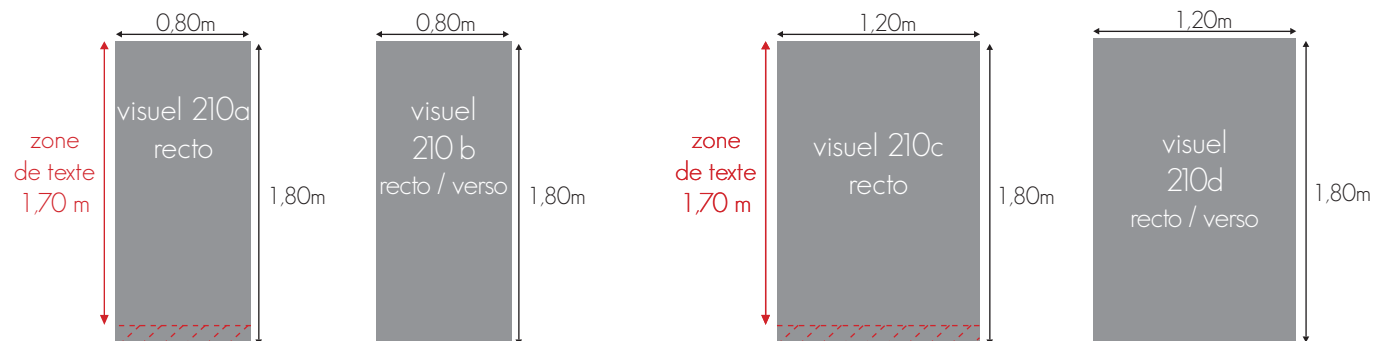

## 211a, 211b

### VISUEL MOBILE / FREE STANDING VISUAL

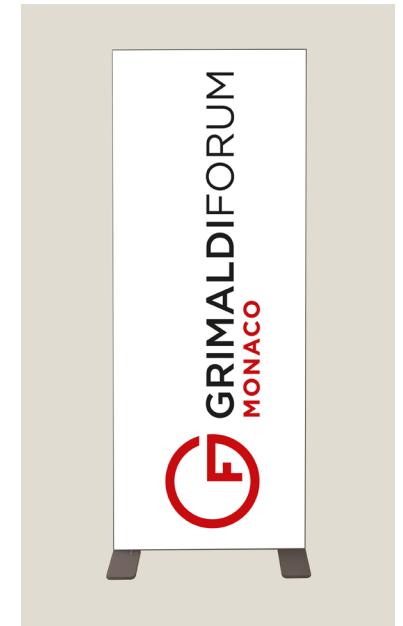

### CARACTÉRISTIQUES / CHARACTERISTICS

Maille polyester fixé sur le cadre.  
Polyester mesh fixed on the frame.

### DIMENSIONS VISIBLES/ VISIBLE SIZE

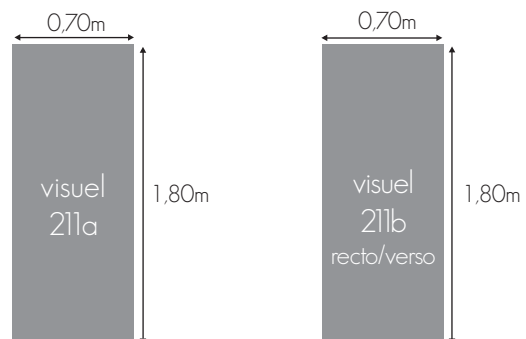

212

**VISUEL DE SOL /  
FLOOR GRAFFIC**

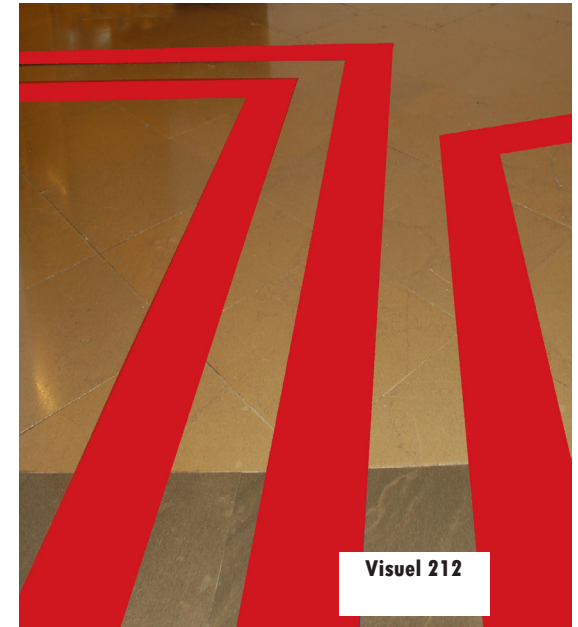

Visuel 212

**CARACTÉRISTIQUES / CHARACTERISTICS**

Adhésif de sol au m<sup>2</sup>.  
Floor graphic per sqm.

## PHOTOCALL ET GRANDE BÂCHE

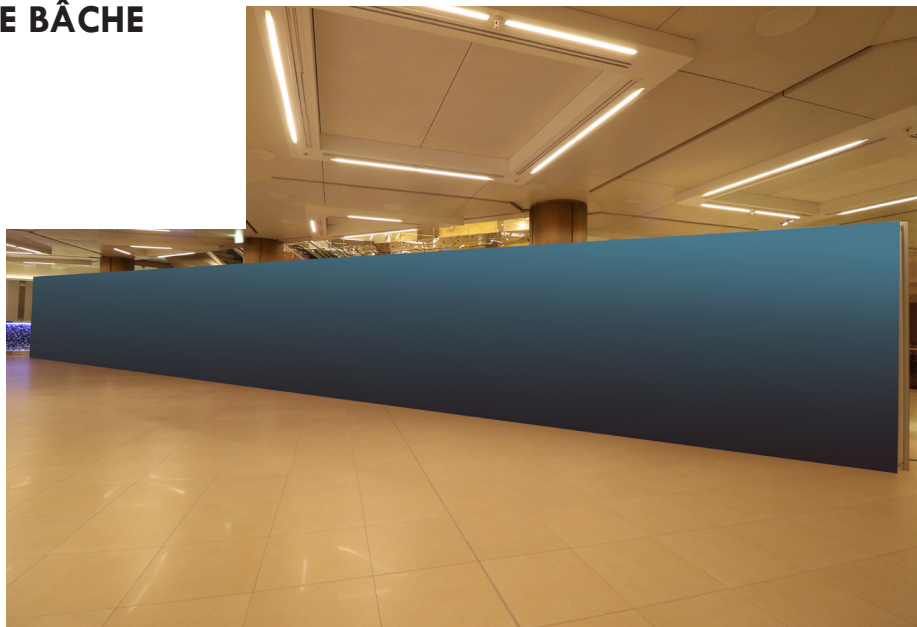

### CARACTÉRISTIQUES / CHARACTERISTICS

Impression sur Blacktex fixée sur châssis bois.  
Blacktex printing on wood frame.

Largeur variable et 2,50m de hauteur.  
Variable width and 2,50m height.

Fichier fourni avec 10 cm de fond perdu.  
File with 10 cm bleed all around.

214a&b

**VISUEL TYPE «CHAUSSETTE» SUR  
STRUCTURE MOBILE /  
«SOCK» TYPE VISUAL ON MOVABLE  
STRUCTURE**

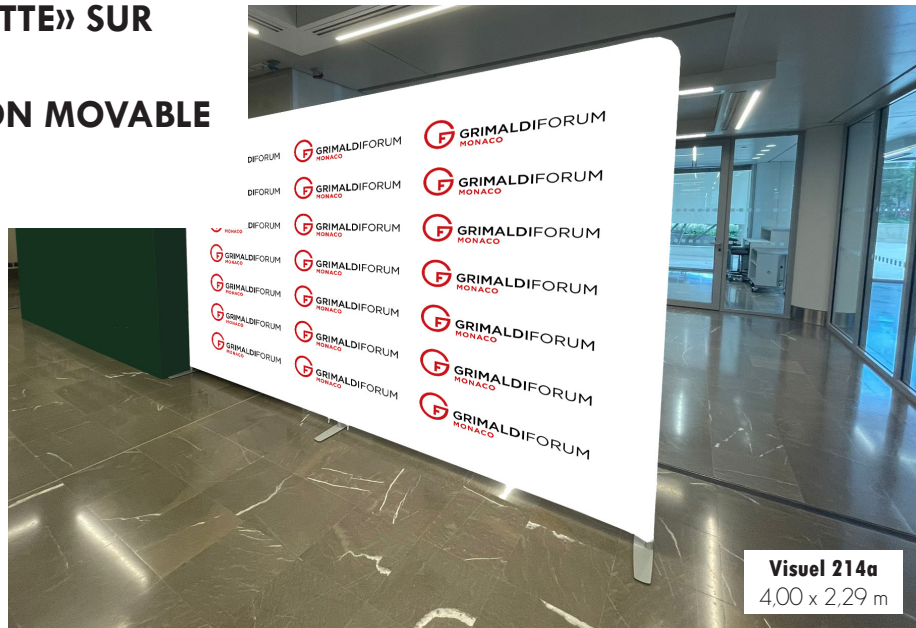

**NOUVEAUTÉ  
NEW**

**CARACTÉRISTIQUES / CHARACTERISTICS**

Maille extensible tendue sur structure aluminium.  
Extensible Polyester mesh stretched on aluminium structure.

**DIMENSIONS VISIBLES/ VISIBLE SIZE**

