

HALL / WELCOME HALL

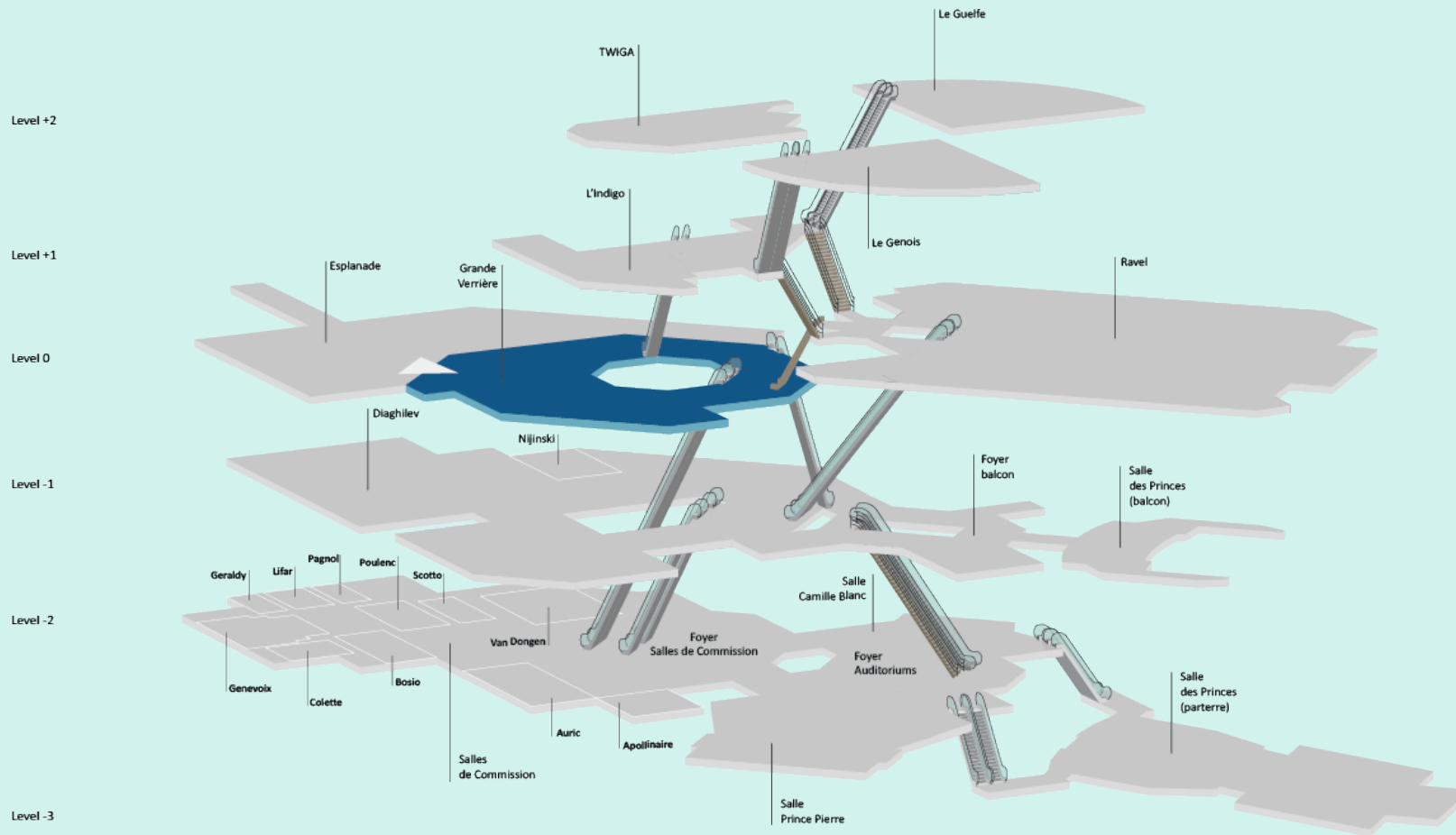

100a , 100b

**BANQUE D'ACCUEIL MOBILE /
WELCOME DESK**



CARACTÉRISTIQUES / CHARACTERISTICS

Impression numérique sur forex.

Digital printing on foamex.

DIMENSIONS VISIBLES/ VISIBLE SIZE

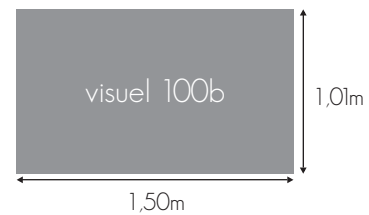
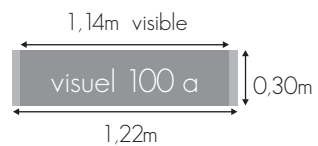

101

BANQUE D'ACCUEIL / WELCOME DESK

Visuel situé sur le bas de la banque d'accueil centrale.
Visual located on the bottom of the central welcome desk.



CARACTÉRISTIQUES / CHARACTERISTICS

Impression numérique sur forex
Digital print on foamex.

DIMENSIONS VISIBLES/ VISIBLE SIZE

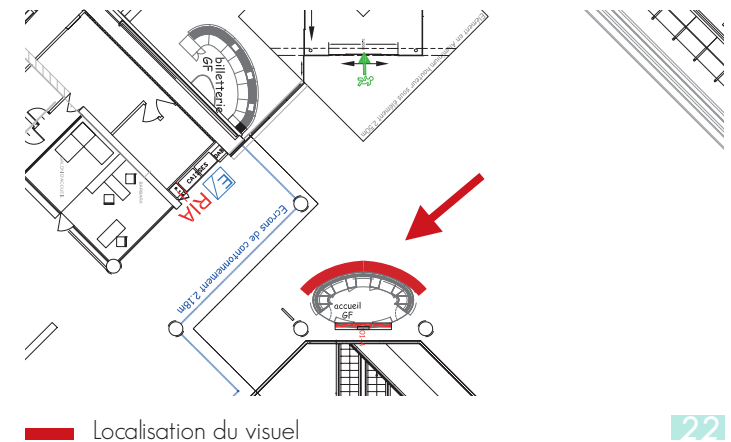
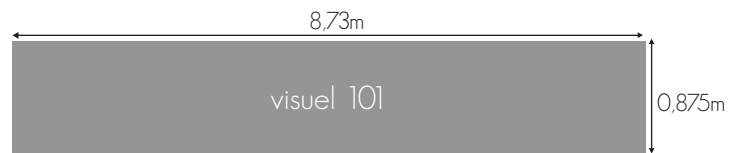

KAKÉMONOS SUSPENDUS / HANGING BANNERS

Visuels suspendus dans le hall d'accueil.
Visuals Hanging in the welcome hall.



CARACTÉRISTIQUES / CHARACTERISTICS

Impression numérique sur forex recto/verso.
Digital printing on foamex both sides.

DIMENSIONS VISIBLES / VISIBLE SIZE

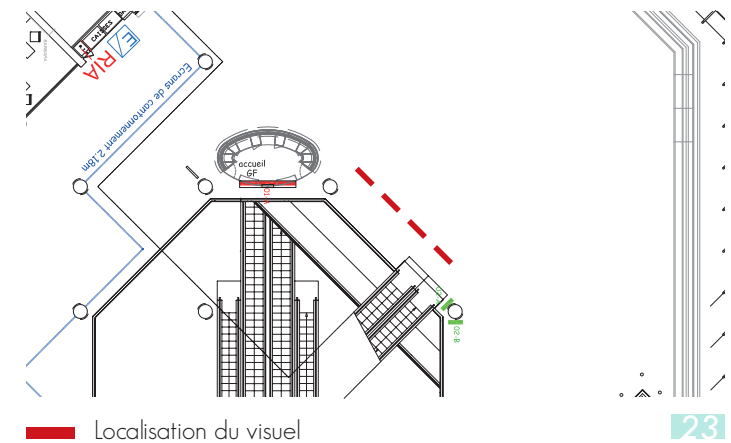
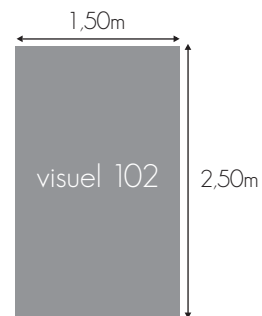

103a, 103b, 103c, 103d

KAKÉMONO COLONNES ATRIUM / ATRIUM BANNER

Visuels situés sur les colonnes de l'atrium.
Visuals located on the atrium columns.



CARACTÉRISTIQUES / CHARACTERISTICS

Visuel une, deux, trois ou quatre faces en bâche PVC fourreaux bas.
Visual with one, two, three or four sides, PVC banner sleeves at bottom.



DIMENSIONS VISIBLES/ VISIBLE SIZE

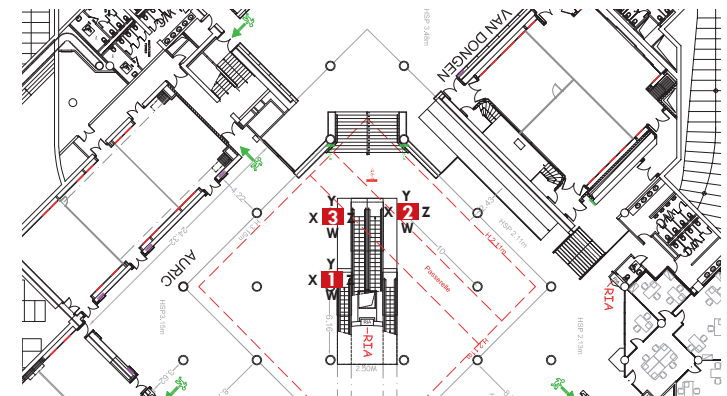
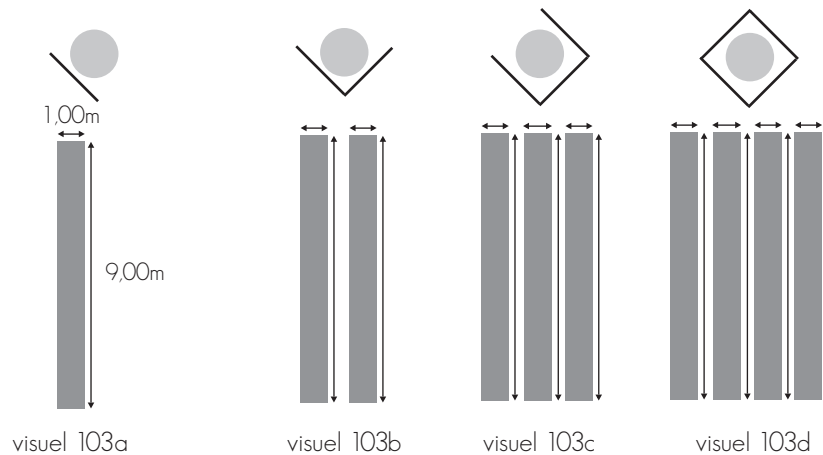

Localisation du visuel

PILLIERS ESPACE HALL VERRIERE / PILLARS OF THE MAIN HALL AREA

Habillage du pilier sur le pourtour.
Graffic wrapped around the pillar.



CARACTÉRISTIQUES / CHARACTERISTICS

Impression numérique sur bâche autour du pilier.
Fabric print adjusted around pillar.

DIMENSIONS VISIBLES/ VISIBLE SIZE

VH1	2,83 x 2,60
VH2	2,83 x 2,60
VH3	2,83 x 2,60
VH4	2,83 x 2,40
AH1	2,83 x 2,40
AH2	2,83 x 2,40
AH3	2,83 x 2,40
AH4	2,83 x 2,40
AH5	2,83 x 2,40
AH6	2,83 x 2,40
AH7	2,83 x 2,40
AH8	2,53 x 2,40

HALL D'ACCUEIL / WELCOME HALL

Visuel situé sur une rambarde visible dans l'atrium.
Visual located on one of the railing visible in the atrium.



CARACTÉRISTIQUES / CHARACTERISTICS

Bâche PVC tendu sur chassis bois.
PVC banner framed.

DIMENSIONS VISIBLES/ VISIBLE SIZE

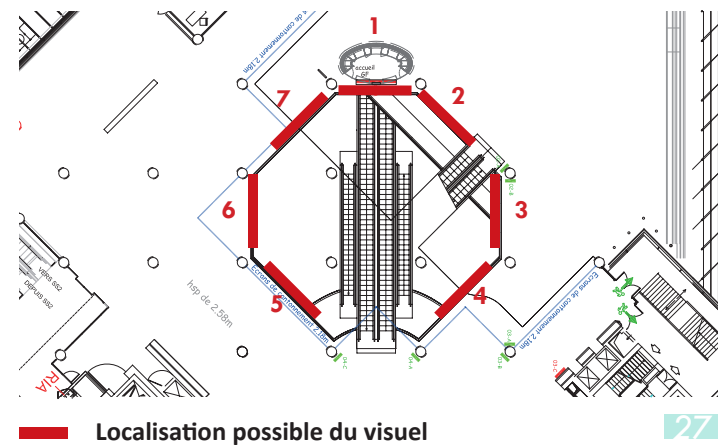
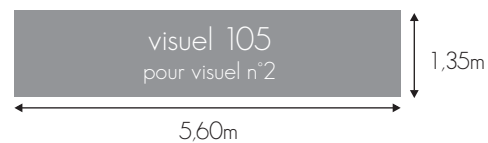
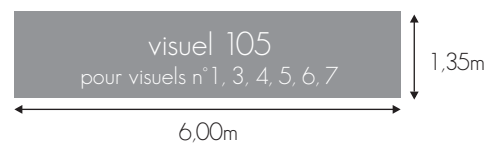

ESCALATOR INDIGO

Visuel situé sur l'escalator qui relie le hall à l'espace Indigo.
 Visual located on the Entrance hall escalators leading to the Indigo area.



CARACTÉRISTIQUES / CHARACTERISTICS

106a : 4 faces adhésives / 4 sides vinyl print. ou
 106b : 6 faces adhésives / 6 sides vinyl print.

visuel intérieur visuel intérieur visuel intérieur visuel intérieur
 2 3 4 5

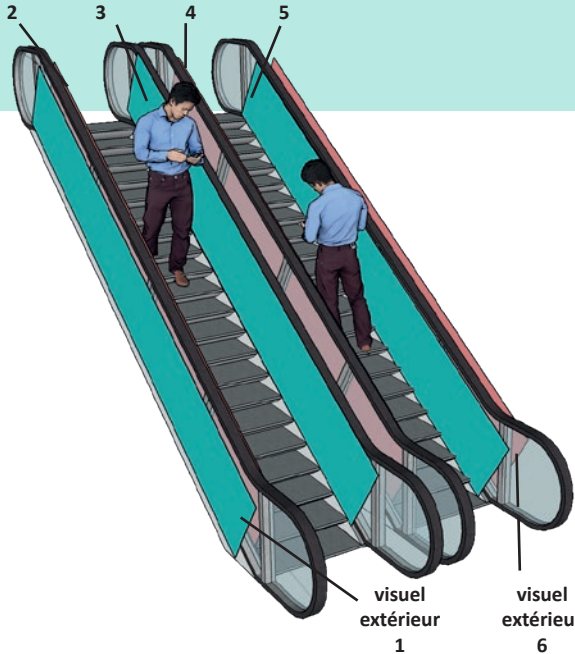

DIMENSIONS VISIBLES/ VISIBLE SIZE

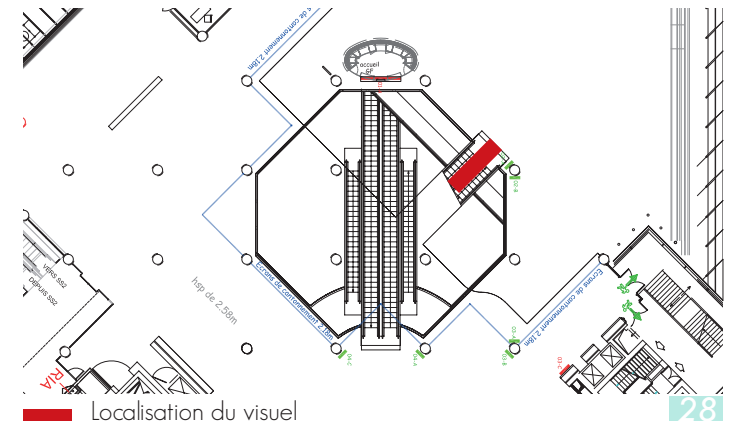

107

ARRIÈRE ÉCRAN ACCUEIL/ BACK WELCOME SCREEN

Visuel situé à l'arrière de l'écran d'accueil dans le hall.
Visual located on the back of the welcome screen in the hall.



CARACTÉRISTIQUES / CHARACTERISTICS

Impression numérique sur bâche fixée sur châssis.
Digital printing on fabric framed.

DIMENSIONS VISIBLES/ VISIBLE SIZE

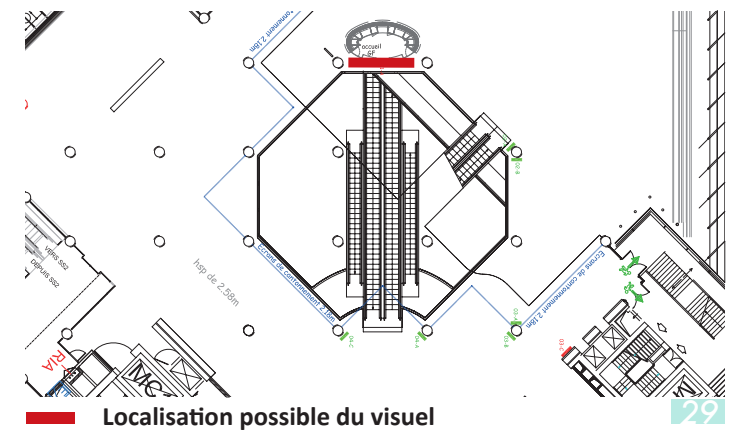
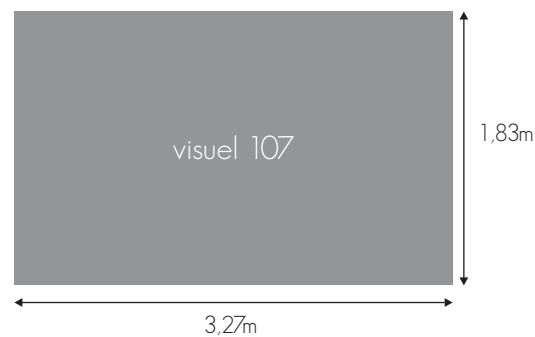

VITRAGES ARRIERE HALL/ WINDOWS BACK OF MAIN HALL

Occultation vitrages ou adhésifs imprimés sur vitrages situés dans l'arrière hall

Blackout or printed adhesive on windows located at the back of the main hall

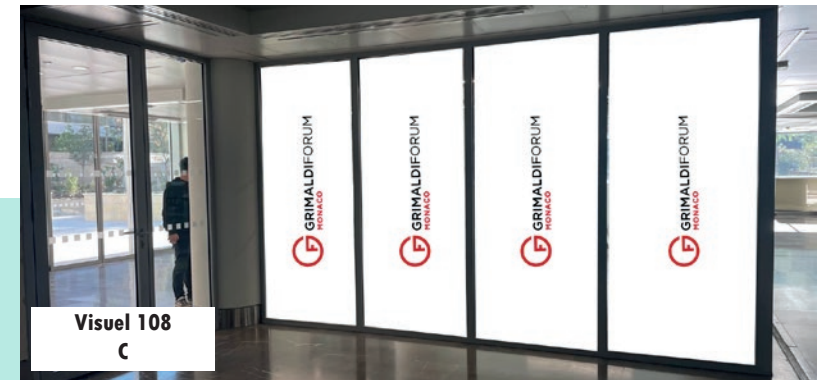
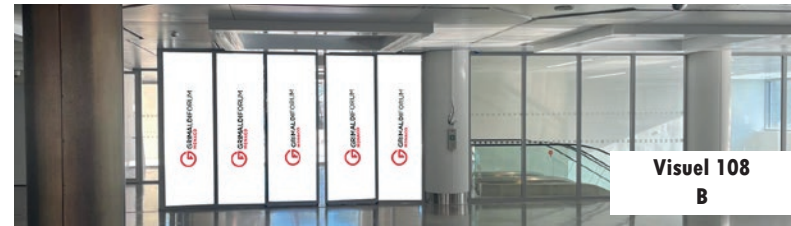

CARACTÉRISTIQUES / CHARACTERISTICS

Impression numérique sur adhésif
Digital printing on vinyl adhesive

DIMENSIONS VISIBLES/ VISIBLE SIZE

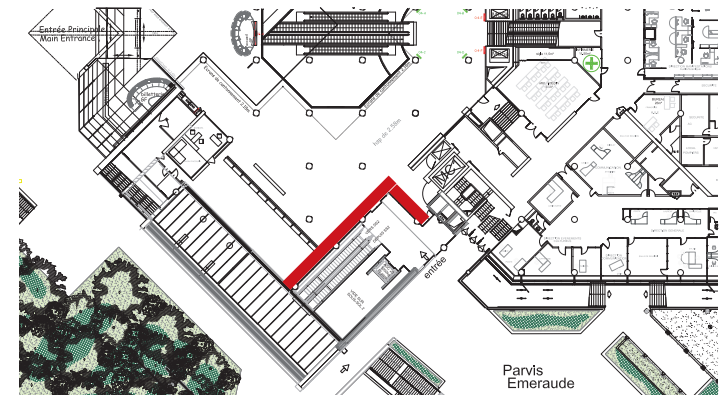
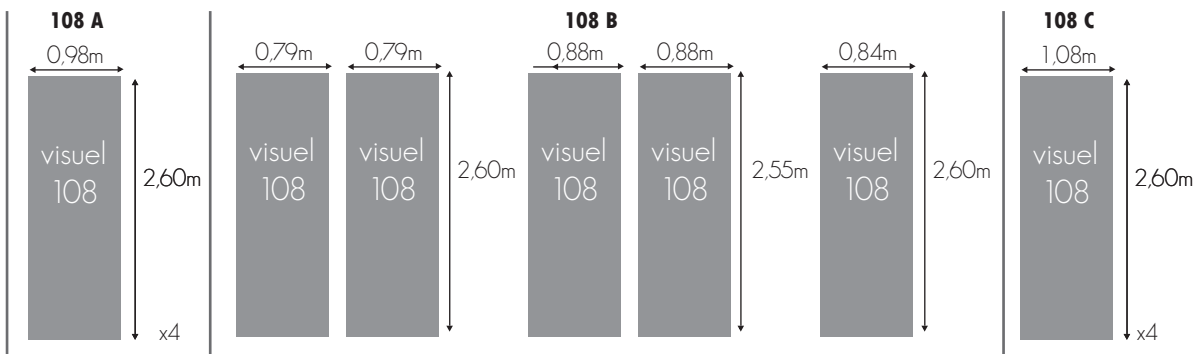

Localisation du visuel

KAKÉMONOS SUSPENDUS / HANGING BANNERS

Visuels suspendus dans l'atrium du grand hall
au dessus de l'escalator central.

Visuals located in the Welcome Hall above the central
escalator.



CARACTÉRISTIQUES / CHARACTERISTICS

5 bâches recto avec fourreaux haut et bas.
5 hanging fabric.



DIMENSIONS VISIBLES/ VISIBLE SIZE

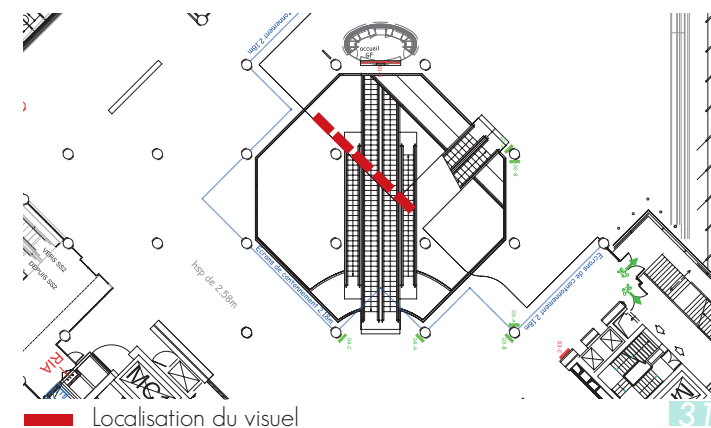

110

ARRIERE HALL/ BACK OF MAIN HALL

Visuel situé devant vitrages dans l'arrière hall/
Visual located in front of windows at the back of main
hall



CARACTÉRISTIQUES / CHARACTERISTICS

Impression numérique sur bâche
Digital printing on fabric

DIMENSIONS VISIBLES/ VISIBLE SIZE

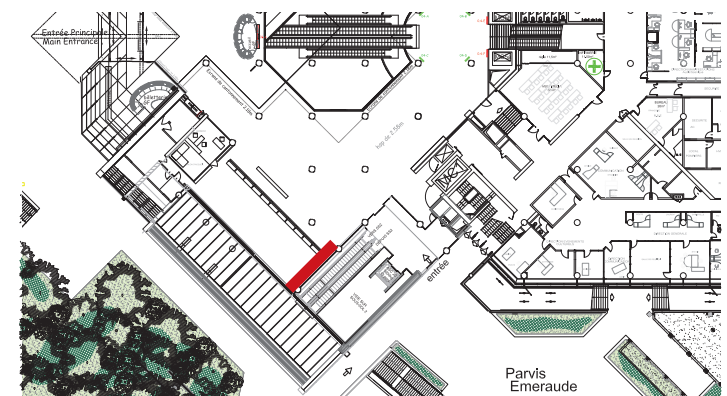
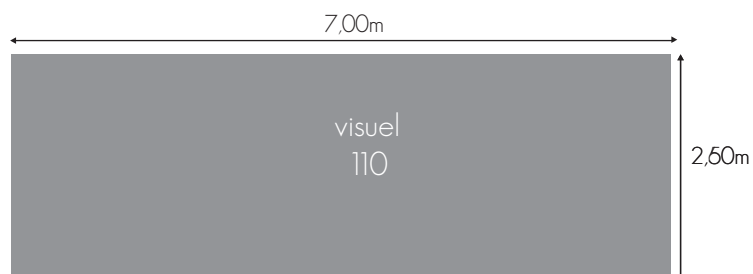

Localisation du visuel

ESCALATOR HALL > SALLES DE COMMISSION / ESCALATOR MAIN HALL > BREAKOUT ROOMS

Visuel situé sur les escalators qui relie le hall au niveaux -2.

Visual located on the escalators connecting main hall with the level -2.

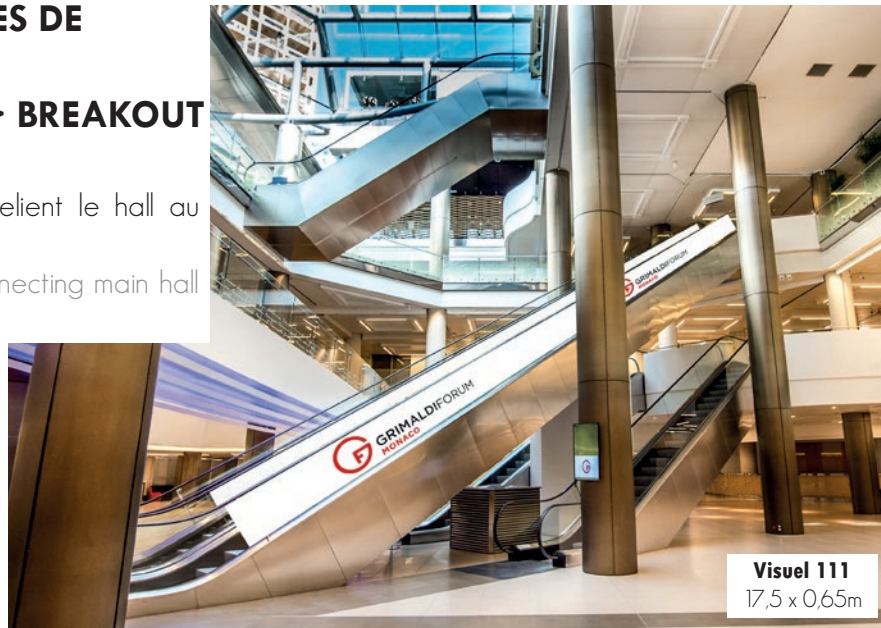

Visuel 111
17,5 x 0,65m



CARACTÉRISTIQUES / CHARACTERISTICS

111a : 4 faces adhésives / 4 sides vinyl print. ou
111b : 6 faces adhésives / 6 sides vinyl print.

visuel intérieur 2 visuel intérieur 3 visuel intérieur 4 visuel intérieur 5

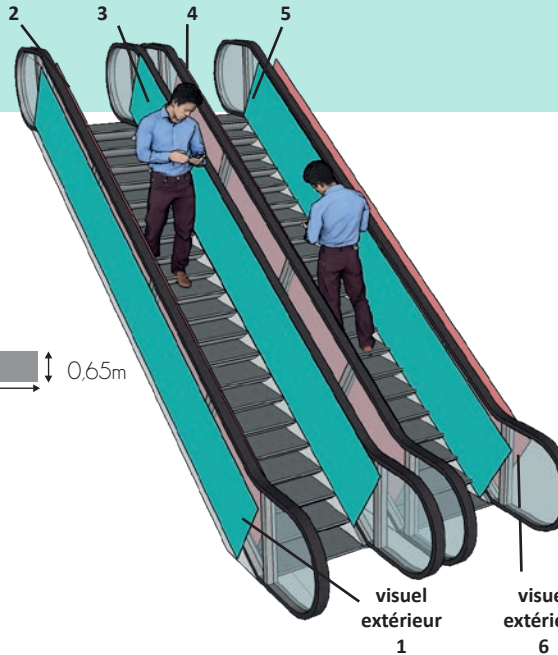

DIMENSIONS VISIBLES/ VISIBLE SIZE

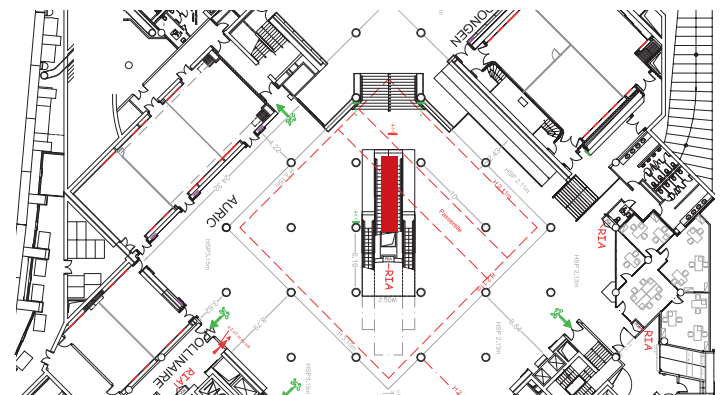

Localisation du visuel

HALL PRINCIPAL / WELCOME HALL

Visuels fixés sur le poteau près de l'escalator menant à l'Indigo.

Visuals on the pillar located next to the escalator leading in the Indigo.



Visuel 113
1,00 x 2,00m



CARACTÉRISTIQUES / CHARACTERISTICS

4 faces en forex.

4 sides foamex.

DIMENSIONS VISIBLES/ VISIBLE SIZE

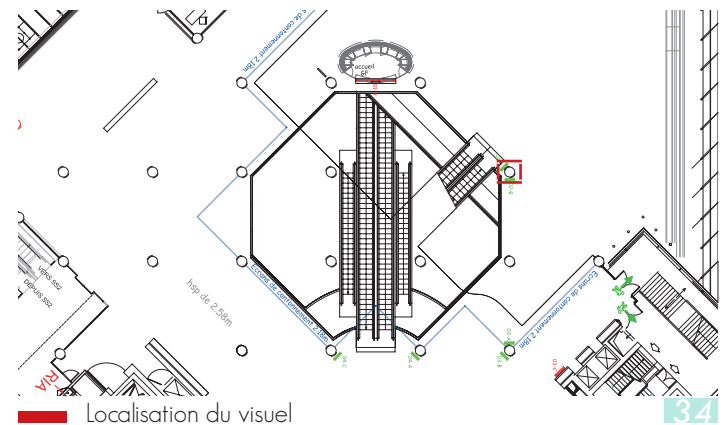
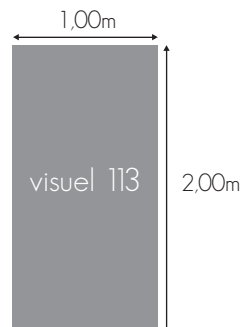

BORNE DE RECHARGEMENT SMARTPHONE / SMARTPHONE CHARGING STATION

Visuel situé sur la borne de rechargement à côté de la banque d'accueil.

Visual located on the charging station next to the welcome desk.



Visuel 114
0,34 x 0,34m

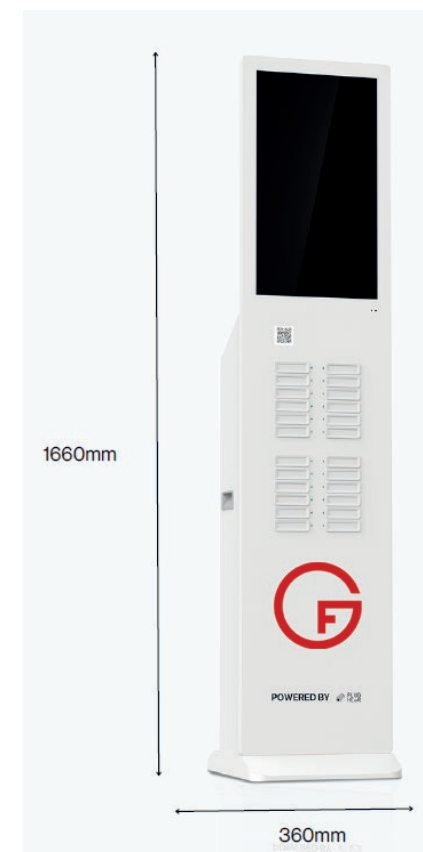

CARACTÉRISTIQUES / CHARACTERISTICS

Impression numérique sur adhésif.

Digital print on vinyl.

DIMENSIONS VISIBLES/ VISIBLE SIZE

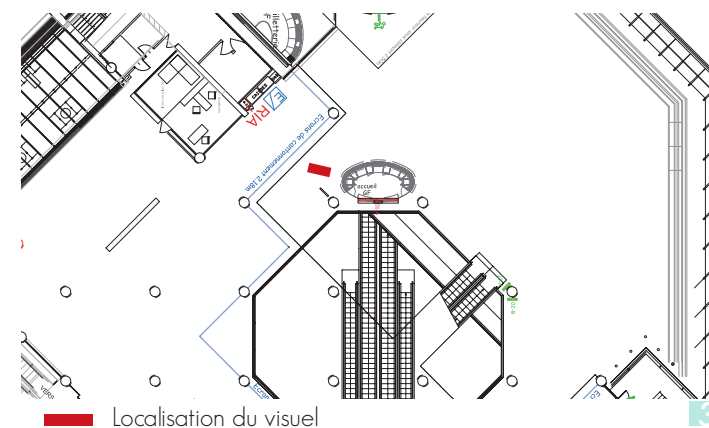
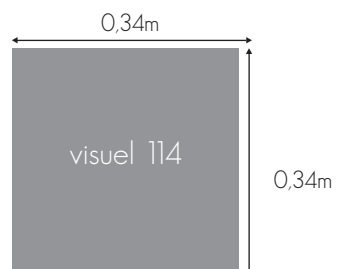

ESCALATOR ENTREE EMERAUDE > DIAGHILEV EST/ ESCALATOR EMERAUDE ENTRANCE > DIAGHILEV EAST

Visuel situé sur les escalators qui relient l'entrée
Emeraude à l'Espace Diaghilev Est
Visual located on the escalators connecting Emeraude
Entrance to Diaghilev East Area

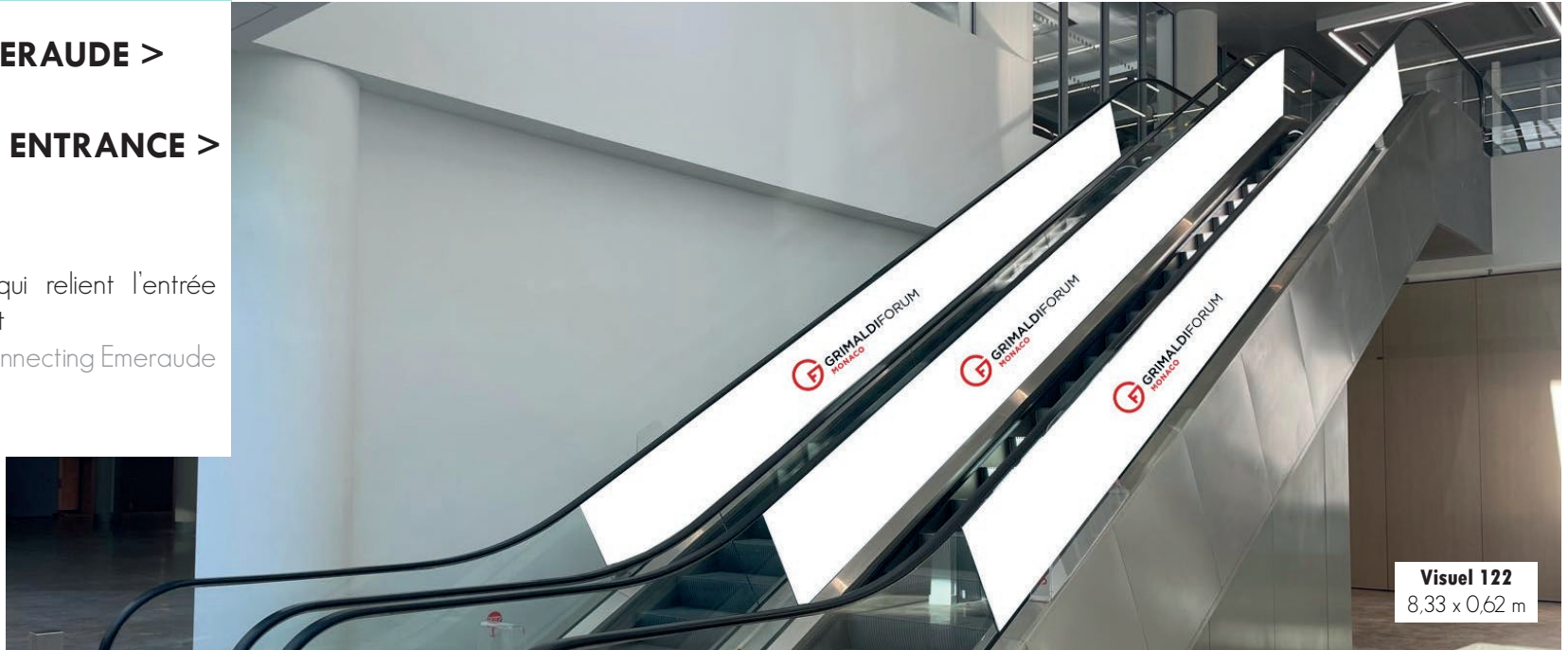

Visuel 122
8,33 x 0,62 m

CARACTÉRISTIQUES / CHARACTERISTICS

Impression numérique sur adhésif
Digital printing on vinyl adhesive

visuel
intérieur 1 visuel
intérieur 2 visuel
intérieur 3 visuel
intérieur 4

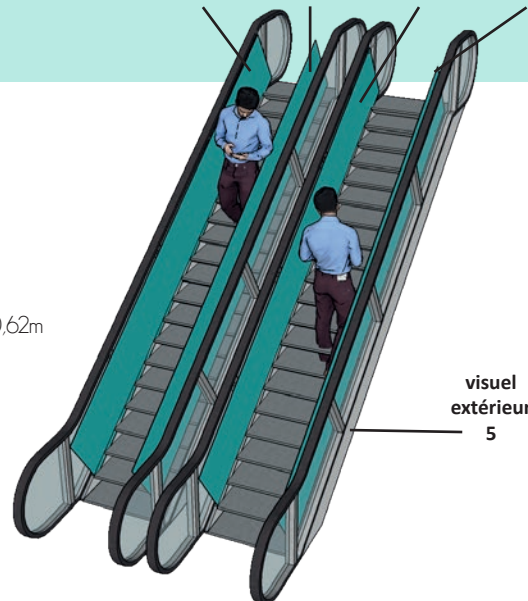

DIMENSIONS VISIBLES/ VISIBLE SIZE

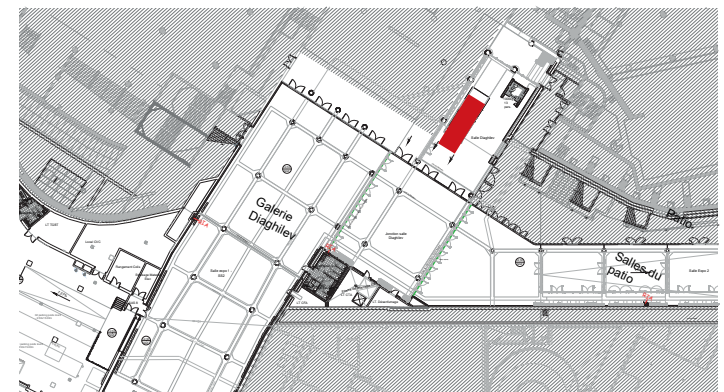
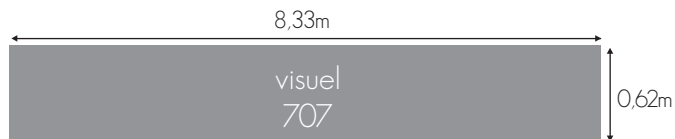

Localisation du visuel